



# GP 12400

## 12V 40Ah

GP 12400 is a general purpose battery up to 5 years in standby service or more than 260 cycles at 100% discharge in cycle service. As with all CSB batteries, all are rechargeable, highly efficient, leak proof and maintenance free.

### Specification

<b>Cells Per Unit</b>	6
<b>Voltage Per Unit</b>	12
<b>Capacity</b>	40Ah @ 20hr-rate to 1.75V per cell @25 °C (77°F)
<b>Weight</b>	Approx. 12.63 kg(27.84 lbs)
<b>Maximum Discharge Current</b>	400A(5sec)
<b>Internal Resistance</b>	Approx. 11 mΩ
<b>Operating Temperature Range</b>	Discharge: -15°C~50°C ( 5°F~122°F) Charge: -15 °C~40°C ( 5°F~104°F) Storage: -15°C~40°C ( 5°F~104°F)
<b>Nominal Operating Temperature Range</b>	25°C±3°C(77°F±5°F)
<b>Float Charging Voltage</b>	13.5 to 13.8 VDC/unit Average at 25°C(77°F)
<b>Recommended Maximum Charging</b>	12A
<b>Current Limit</b>	
<b>Equalization and Cycle Service</b>	14.4 to 15.0 VDC/unit Average at 25°C(77°F)
<b>Self Discharge</b>	CSB Batteries can be stored for more than 6 months at 25°C(77°F). Please charge batteries before using. For higher temperatures the time interval will be shorter.
<b>Terminal</b>	B2-L terminal to accept M5 nut & bolt
<b>Container Material</b>	ABS(UL 94-HB/File E50263)*Flammability resistance of (UL 94-V0/File E88637) can be available upon request.



CSB-manufactured batteries are UL-recognized components under UL924 and UL1989. CSB is also certified by ISO 9001 and ISO 14001.

### Dimensions

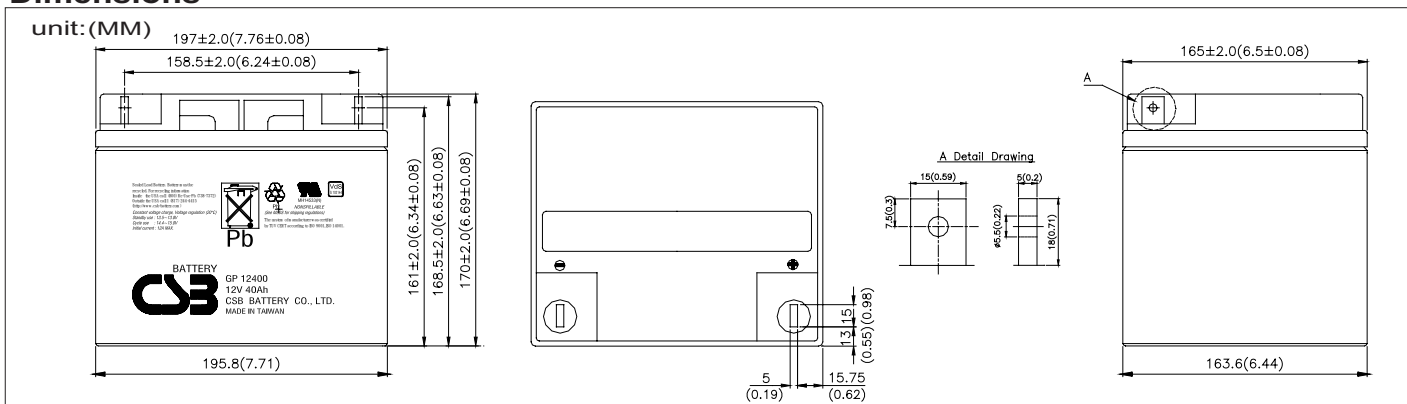

### Constant Current Discharge Characteristics Unit:A (25°C, 77°F)

F.V/Time	5MIN	10MIN	15MIN	30MIN	1HR	2HR	3HR	4HR	5HR	8HR	10HR	20HR
1.60V	176	113	85.0	51.8	30.6	17.7	12.6	9.83	8.01	5.25	4.28	2.21
1.67V	157	105	81.0	50.8	30.3	17.6	12.5	9.77	7.98	5.19	4.20	2.12
1.70V	149	101	78.7	50.1	30.2	17.5	12.4	9.75	7.96	5.17	4.16	2.08
1.75V	135	95.0	75.5	49.0	30.0	17.4	12.3	9.71	7.93	5.10	4.09	2.01
1.80V	121	88.3	71.7	47.6	29.8	17.3	12.2	9.67	7.89	5.03	4.03	1.93
1.85V	107	81.7	67.8	46.2	29.4	17.2	12.1	9.63	7.85	4.96	3.96	1.86

### Constant Power Discharge Characteristics Unit:W (25°C, 77°F)

F.V/Time	5MIN	10MIN	15MIN	30MIN	1HR	2HR	3HR	4HR	5HR	8HR	10HR	20HR
1.60V	2,110	1,350	1,020	622	367	212	151	118	96.1	63.0	51.3	26.5
1.67V	1,886	1,259	972	606	364	211	150	117	95.7	62.3	50.4	25.4
1.70V	1,790	1,214	945	600	363	210	149	116	95.5	62.0	50.0	24.9
1.75V	1,620	1,140	902	585	360	209	148	115	95.2	61.2	49.2	24.1
1.80V	1,450	1,060	860	571	357	208	147	114	94.8	60.4	48.3	23.2
1.85V	1,280	980	814	555	353	207	146	113	94.2	59.6	47.5	22.4

• All mentioned values are average values.  
• Tolerance: X<6min(+15%~-15%), 6min ≤ X<10min(+12%~-12%), 10min ≤ X<60min(+8%~-8%), X ≥ 60min(+5%~-5%)

### Trickle (or Float) Service Life

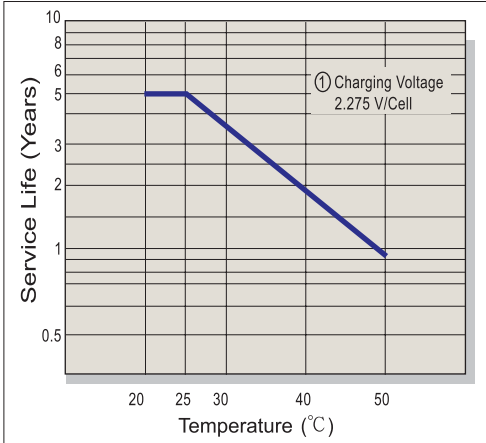

### Capacity Retention Characteristic

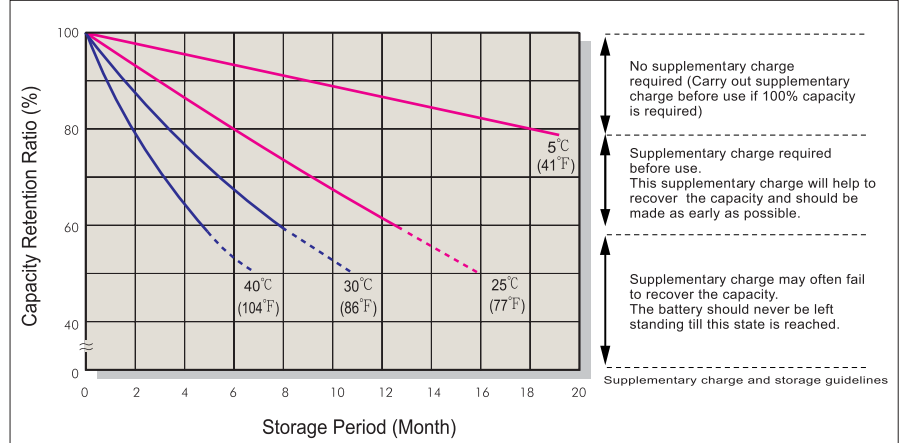

### Battery Voltage and Charge Time for Standby Use

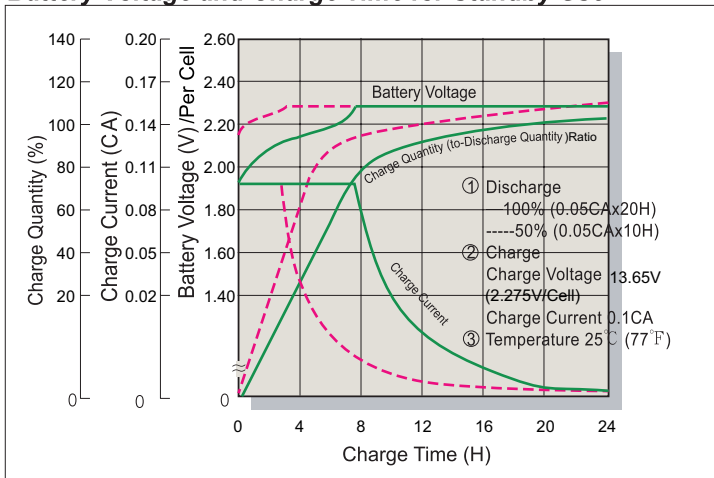

### Cycle Service Life

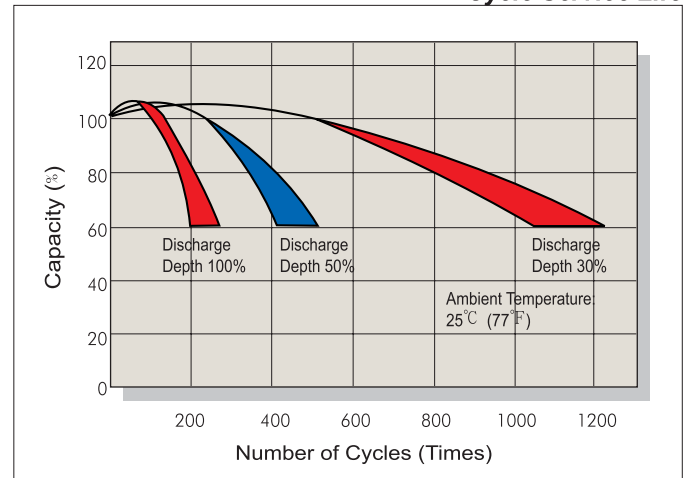

### Battery Voltage and Charge Time for Cycle Use

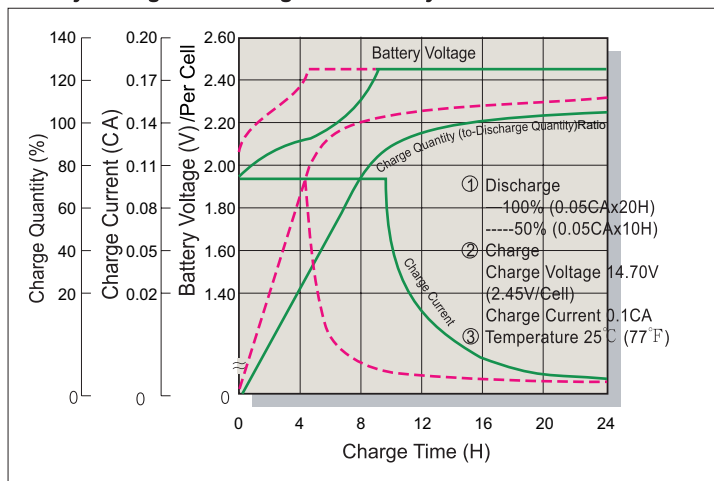

### Terminal Voltage (V) and Discharge Time

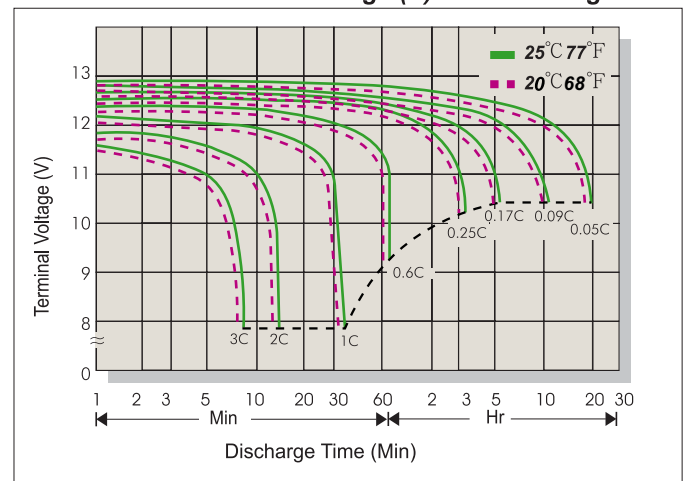

### Charging Procedures

Application	Charge Voltage(V/Cell)			Max.Charge Current
	Temperature	Set Point	Allowable Range	
Cycle Use	25°C (77°F)	2.45	2.40~2.50	0.3C
Standby	25°C (77°F)	2.275	2.25~2.30	

### Discharge Current VS. Discharge Voltage

Final Discharge Voltage V/Cell	1.75	1.70	1.60	1.30
Discharge Current(A)	0.2C>(A)	0.2C<(A)<0.5C	0.5C<(A)<1.0C	(A)>1.0C

Sales Office URL: [WWW.CSB-BATTERY.COM](http://WWW.CSB-BATTERY.COM)

**CSB BATTERY CO., LTD.**  
 TAIWAN OFFICE  
 Tel: +886-2-2555-5600  
 Fax: +886-2-2555-3300  
 E-mail: service@csb-battery.com.tw

**CSB BATTERY TECHNOLOGIES (BEIJING) CO., LTD.**  
 BEIJING OFFICE  
 Tel: +86-10-59621300/59621301/59621302/59621303  
 Fax: +86-10-59621304  
 mail: chinasl@csb-battery.com

**CSB BATTERY TECHNOLOGIES, INC**  
 USA OFFICE  
 Tel: +1-817-244-7777/1-8003 CSBUSA(272872)  
 Fax: +1-817-244-4445  
 E-mail: csb@csb-battery.com

**CSB BATTERY LOGISTICS (SHANGHAI) CO., LTD.**  
 SHANGHAI OFFICE  
 Tel: +86-21-5046-1622, 5046-0833  
 Fax: +86-21-5064-3314  
 E-mail: chinasl@csb-battery.com

**CSB BATTERY OF NETHERLANDS B.V**  
 NETHERLANDS OFFICE  
 Tel: +31(0) 180 418 140  
 Fax: +31(0) 180 418 327  
 E-mail: eurosales@csb-battery.com

**CSB BATTERY LOGISTIC (SHANGHAI) CO., LTD.**  
 SHENZHEN OFFICE  
 Tel: +86-755-8831-6488/6396/16356  
 Fax: +86-755-8831-6548  
 mail: she@csb-battery.com.cn